

ELMO

VISUAL PRESENTER

P30S

The Ultimate Faculty Enhancer



NEW

Welcome to the Real World of Visual Presentation
HD/Full-Motion Visual Presenter P30S



Quick, Easy, and Flexible



Visual Power



Expanded Possibilities



ELMO's Checklist for Effective Visual Presentations:

- A variety of materials presented clearly and directly
- Real-world materials, not virtual representations
- An element of surprise to capture viewer attention



- 1.35-megapixel CMOS image sensor
- Advanced 64x zoom and auto focus
- 30 fps for smooth motion display
- HDTV- and 16:9-compatible

Even in an increasingly virtual world, reality is often the best teacher. Actual specimens, real three-dimensional objects, authentic documents, and pages directly from a book all make visual presentations more diverse, realistic, and vivid. Make the most of your real-world materials with an ELMO P30S Visual Presenter. Deliver real-time, true-to-life presentations that catch and keep the attention of everyone in the room. Integrate your resources into data files for easy transfer to a PC or SD card storage. And let the learning begin.

Built-in 3.5-inch LCD monitor

Thanks to the built-in 3.5-inch LCD monitor, you see before you on the control panel exactly what viewers see behind you on the screen. This way, you can adjust your materials as needed and continue your presentation without ever turning around or missing a beat.



Flexible free-angle camera arm

Broaden the view and heighten your impact. The flexible camera arm lets you capture your subjects from any angle and focus attention precisely where you want it. Simply lower the arm and rotate the camera head to project an intriguing bottom-to-top look at a three-dimensional object.

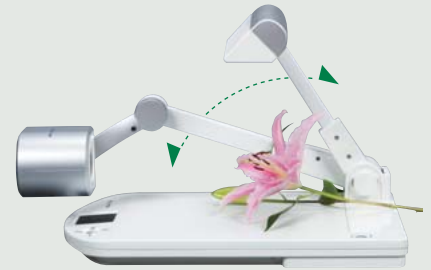

1.35-megapixel CMOS image sensor

For vivid, high-resolution images that keep viewers engaged, the P30S relies on a horizontal resolution of 800 lines—meeting the highest industry standard—a highly precise 1,350,000-pixel CMOS image sensor, and a specially designed lens that minimises distortion and light falloff around the edges. The resulting images are as even as they are beautiful.



Advanced 64x zoom and auto focus

For unsurpassed clarity, the P30S boasts a camera unit, made up of a special lens and zoom component, that was designed exclusively for the P30S. High-magnification 16x optical zoom and 4x digital zoom ensure that all materials—from three-dimensional objects or books to special items such as slides—are faithfully displayed down to the most intricate detail. Even the tiniest display subjects appear distortion-free. And with one-push auto focus, the P30S instantly and automatically determines and sets just the right focus for the sharpest, crispest detail possible.



USB 2.0 PC interface

The P30S is conveniently equipped with a USB port for easy image transfer to a PC. It can even be used as a 3D scanner. Bundled Image Mate software lets you easily monitor, capture, edit, and save any image on your PC. This presentation-boosting software provides annotation tools for drawing lines or boxes in a variety of colours on captured images and a screen separation function for side-by-side comparisons of live video and stored images. The P30S also has TWAIN compatibility that brings you the versatility to import saved image files to commercially available photo retouching software.



Annotation

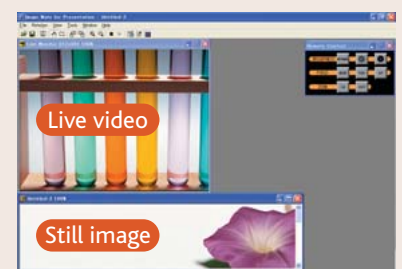

Screen Separation function

Easy access to primary functions

With zoom and auto focus conveniently concentrated on the camera head, you can zoom in, zoom out, and adjust the focus as needed without disrupting the flow of your presentation. Other frequently used functions have been conveniently concentrated in plain view on the control panel for easy operation. Everything is right at your fingertips for immediate access.



Quick setup

With just one simple movement, the camera and light on the compact P30S are ready for action. And both can be easily folded down when no longer needed. This quick and easy setup gets your presentations off to the smoothest of starts.

30 fps for smooth motion display

At 30 frames per second, the P30S smoothly captures and reproduces moving images. The high frame rate helps eliminate the stroboscopic effects produced when the zoom adjusts itself or the display subject is moved and the after-images produced when the subject is changed.



HDTV- and 16:9-compatible

Thanks to a 1280x720-dot HDTV output, the P30S easily accommodates even 16:9 high-definition TV monitors—without elongating the display image. And progressive scanning prevents on-screen flickering and blurring for distraction-free viewing.

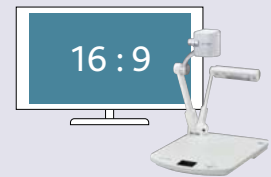

Clear text mode

To accentuate the difference between black and white on monochrome texts, the P30S is equipped with a contrast-enhancing text mode. As a result, letters and numbers are clearly reproduced, facilitating the reading of even very small text and ensuring that your presentation has the intended impact.

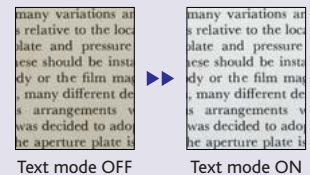

SD card-ready

Now there's no need to bring a PC and other hardware to every presentation. For slide show presentations, simply store your images on an SD card (sold separately). You and the SD-card-accommodating P30S are ready to go.

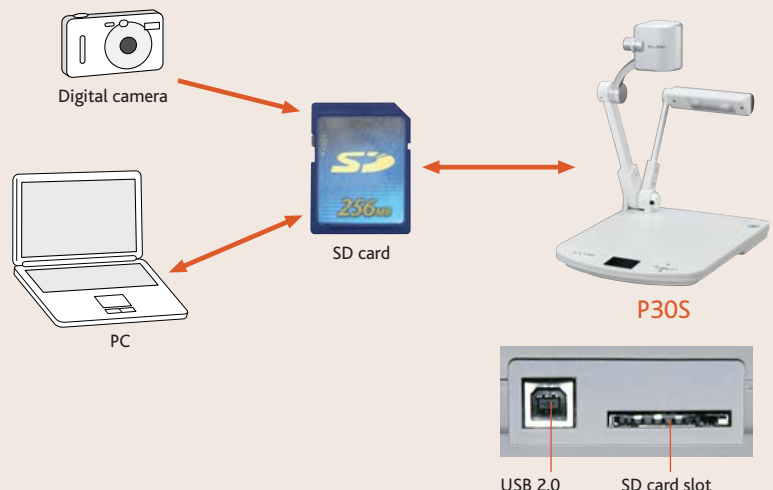

P30S Specifications

Model	P30S		
Camera	Image pick-up device	1/3" CMOS, 1,350,000 pixels	
	Effective pixels	SXGA output	1280 (H) x 1024 (V)
		HD 720p output	1280 (H) x 720 (V)
		XGA output	1280 (H) x 960 (V)
Frame rate	30 frames/sec.		
Resolution	RGB output	800 (H) x 800 (V) TV lines	
	Video output	450 (H) TV lines	
Optics	Zoom	Powered, 16x optical	
	Lens	F2.7, f=4.9 to 78.4 mm	
	Shooting area	SXGA	Max. 405 x 324 mm, min. 30 x 24 mm
		HDTV	Max. 405 x 224 mm, min. 30 x 17 mm
		XGA	Max. 405 x 303 mm, min. 30 x 23 mm
Focus	Auto/Manual (powered)		
Functions	White balance	Full-Auto/One-Push/Manual	
	Negative/positive conversion	Provided	
	Image mode	Text 1, Text 2, Text 3, Graphics	
	Edge enhancement	Provided (in Graphics mode)	
	Colour/B&W selection	Provided	
	Pause mode	Provided	
	Digital zoom	Provided (4x)	
	Gamma adjustment	Provided (in Graphics mode)	
	OSD (on-screen display)	Provided	
	Slide show	Provided (SD card image)	
	Split screen	Provided (SD card image, 9-split, 16-split)	
	Image save	Provided (onto SD card)	
	Image rotation	Provided (0°, 180° for forward shooting)	
	State presetting	Up to 8 user settings	
	Annotation	Provided (on PC screen)	
	Screen separation	Provided (on PC screen; live image + saved image)	
	Sync. system	Internal	
Interface	Internal selection	Int./RGB	
	Analogue RGB output	SXGA (1280 x 1024 @60Hz)	
		HD 720p (1280 x 720 @60Hz)	
		XGA (1024 x 768 @60Hz)	
	Video output	Composite (x1), S-Video (x1)	
	DVI output	Provided (x1)	
	RGB input	Provided (x1)	
	RS-232C port	Provided (x1)	
USB port	Provided (x1)		
Memory card	SD card slot		
Lighting	Upper lighting unit		
Others	Accessories	AC adapter, Power cord (1.5 m), Video RCA cable (3 m), RGB cable (2 m), DVI cable (2 m), S-Video cable (2 m), USB cable (1.8 m), Instruction manual, IR remote control, Slide shooting adapter, Remote control case, Utility software (Image Mate) CD-ROM	
	Dimensions (W x D x H)	Set up	376 x 482 x 549 mm
		Folded	376 x 482 x 181 mm
	Weight	4.6 kg	
	Built-in 3.5" LCD monitor	Provided	
	Application software	Image Mate for Presentation, Image Mate for Movie Creation, TWAIN driver (Windows® 2000 [SP4 or later], Windows® XP [SP2 or later], Windows Vista™ [32-bit], Mac OS X)	
	Power source	AC 100 to 240V, 50/60Hz	

H: horizontal, V: vertical

Design and specifications are subject to change without prior notice. The images in this brochure are simulated. "ELMO" is a trademark of ELMO COMPANY, LIMITED. SD logo is a trademark. Other brand names and product names may be trademarks or registered trademarks of their respective owners.

ELMO's Helping to Provide a Greener Future for Our Children

This ELMO product complies with RoHS Directive 2002/95/EC (Restriction Of the use of certain Hazardous Substances in electronic equipment). This compliance helps to ensure a healthier and greener environment for all our children.

Profile

All dimensions in mm

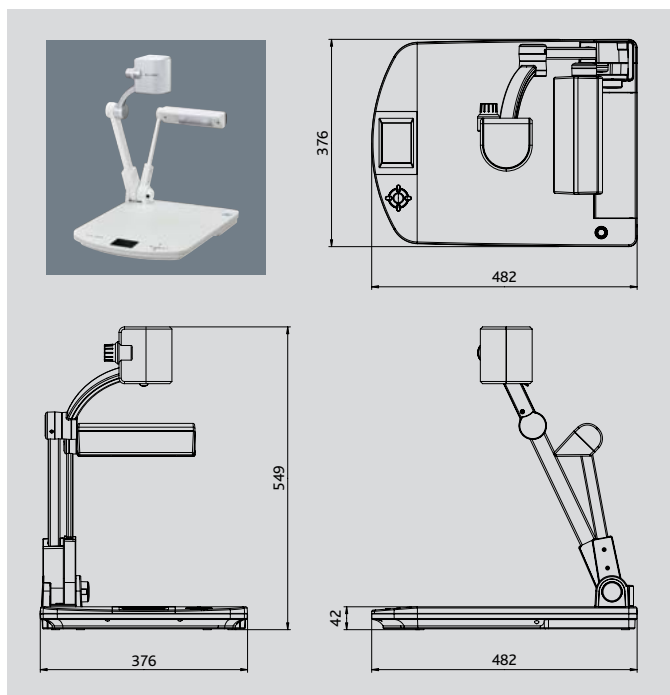

Rear Panel

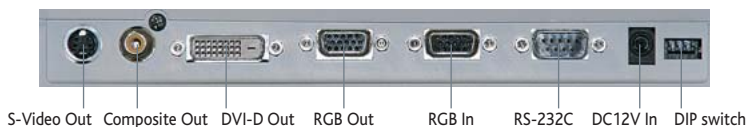

Supplied accessory



Slide Shooting Adapter



ELMO CO., LTD. is one of the sponsors for Japan Committee Vaccines for the World's Children (JCV).

JCV operates under basic guidelines and objectives of the Children's Vaccine Initiative (CVI) founded in 1990 by UNICEF, WHO, UNDP, the Rockefeller Foundation, and the World Bank.

ISO 9001
JP 95/05165QA
ISO 14001
TW 01/19851EM

ELMO CO., LTD. (Head Office and Factory's) QMS/EMS has been registered to ISO 9001 & 14001 : 2004.

ELMO
FOCUS ON THE FUTURE

ELMO CO., LTD.

6-14, Meizen-cho, Mizuho-ku
Nagoya, 467-8567, Japan

Distributed by

Additional technical information is available from any of the following subsidiary companies:

ELMO (Europe) G.m.b.H.

Neanderstr. 18
40233 Düsseldorf, Germany
Tel. (0211) 386470 Fax. (0211) 376630
E-mail : info@elmoeurope.com
Web : <http://www.elmoeurope.com>

ELMO USA Corp.

Headquarters
1478 Old Country Road
Plainview, NY 11803-5034, U.S.A.
Tel. (516) 501-1400 Fax. (516) 501-0429
E-mail : elmo@elmousa.com
Web : <http://www.elmousa.com>

West Coast Branch

Cypress Pointe Business Park
5676 Corporate Avenue
Cypress, CA 90630, U.S.A.
Tel. (714) 828-8457 Fax. (714) 828-8429



This brochure is printed on recycled paper with soy ink.

Printed in Japan (O) 02/2008